



ruk-tech.com

Modules & Tools

RUK digital cutter





High-Speed Oscillating Tool EOT

Applicable models: MTC/MBC/F1

Cutting speed	300-1200mm/s
Motor speed	17000-21000RPM
Max thickness	≤25mm (according to different materials)
Cutting materials	KT board, display board, solid cardboard, rubber, leather, low density PVC expansion sheet within 1cm
Blade Angle	0.64mm/1mm

The Oscillating tool adopts the motor imported from Switzerland. It is Widely used in cutting within 10mm PVC, KT board and other medium-density material, Various types of blades 45°,26°,16° for choice to cut different materials.





Applicable models: MTC/MBC/F1

Cutting speed	300-1500mm/s
Max thickness	≤25mm (according to different materials)
Cutting materials	PP paper, self-adhesive, magnetic material, vinyl, honeycomb, electronic film, within 5mm PVC expansion sheet, etc.

The tool itself without motor or other power output, more suitable for full-through cutting PVC materials below 5mm and rolls, light box cloth and other flexible materials, universal cutting tool is more widely used, according to the different materials to choose different angles of the blade, and determine the angle of the blade is the thickness of the material itself.



Universal Cutting Tool
UCT

RUK



Kiss-cut Tool
KCT

Applicable models: MTC/MBC/F1

Cutting speed	300-1500mm/s
Max thickness	≤25mm (according to different materials)
Cutting materials	Self-adhesive, vinyl, decorative film, reflective film, etc.

Kiss-cut tool can automatically adjust the depth of the tip to do only cut through the upper half of the material without damaging the lower half of the material, mainly used in labeling, stickers and other materials cutting, cutting speed can reach the fastest 1m / s, can replace the work of the word cutter.



RUK



V-cut Tool

VCT



Applicable models: MTC/MBC/F1

Cutting speed	300-600mm/s
Max thickness	≤25mm (according to different materials)
Cutting materials	KT board, PVC, corrugated board, honeycomb board, polyester fiber board, display board, foam core board, etc

The V-CUT tool is perfect for cutting moderate hard PVC, corrugated, honeycomb panels to produce complex structural designs. The tool can be set for cutting 4 different angles for different cutting requests, such as: 15° 30° 45° 60°



Applicable models: MTC/MBC/F1



Foam Cut Tool
FCT

Cutting speed	100-500mm/s
Max thickness	≤50mm (according to different materials)
Cutting materials	EVA, foam, sponge, etc.
Motor speed	17000RPM/M

Through the principle of high-frequency vibration to the material for full-permeability cutting, mainly quoted in the internal partition of the carton or advertising industry foam characters cutting, the maximum cutting thickness of 50mm, foam knife tool power supply is 38V.



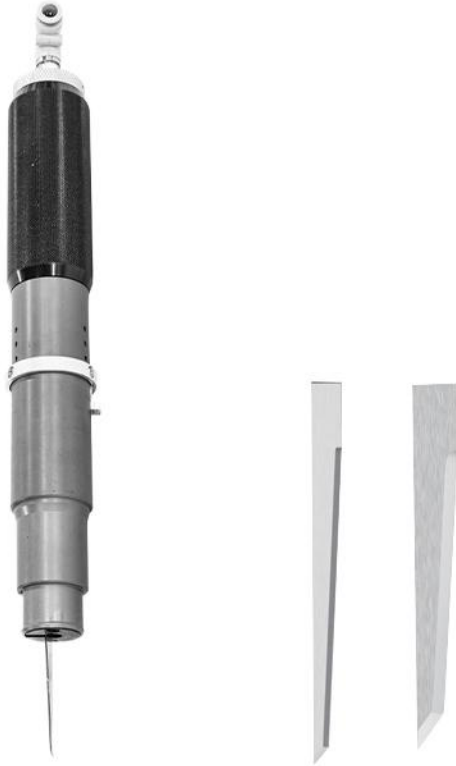

Pneumatic oscillating tool POT

Applicable models: MBC/MTC

Cutting speed	50-300mm/s
Max thickness	50mm (according to different materials)
Cutting materials	foam, sponge, EVA, etc.
Air pressure	< 0.7MPa
Knife SPC.	1*6*48mm
Amplitude	8mm

The pneumatic oscillating tool is an air driven tool at high frequency to cut materials. Stroke is adjustable up to 8mm, and is capable of cutting high density materials.



EVA



Foam



Sponge



EVA

RUK



Dotted Creasing Wheel DCW

Applicable models: MBC/MTC

Cutting speed	800-1000mm/s
Max thickness	≤7mm (according to different materials)
Cutting materials	cardboard/corrugated paper, etc.

Cut in any direction with a point-breaking knife to form easy-tear lines, gears can be customized.



Napkin box



Cardboard



Corrugated paper



Photo paper



Creasing Tool

Applicable models: MBC/MTC

Cutting speed	800-1500mm/s
Max thickness	≤7mm (according to different materials)
Cutting materials	cardboard / PET board /corrugated paper

Creasing wheel tool is used to do the creasing on the corrugated board, card board, hollow sheet materials, different creasing wheels for different materials can make perfect creasing with 4 different size wheels.



Applicable models: MBC

Pre-pressing wheels can effectively prevent materials from moving or warping, such as corrugated cardboard.



Pre-pressure Wheel



Applicable Models: MBC/MTC/MEC



Cutting speed	100-500mm/s
Motor speed	maximum60000RPM
Spindle power	1.5KW
Max thickness	≤25mm (according to different materials)
Cutting materials	within 25mm acrylic, aluminum,composites,MDF board,plastic,hard foam and other high-density materials

The milling tool has a perfect performance on the hard materials, such as acrylic, Aluminum composite panel, MDF and other high density material, it can do precise engraving like the kiss cut for different depth. And it is also equipped with the dust cleaner and chiller.



Water-Cooled Milling Tool
MT



Mini Oscillating Tool

EOT

Applicable models: MKC

Cutting speed	300-1000mm/s
Motor speed	17000RPM
Max thickness	≤25mm (according to different materials)
Cutting materials	KT board, display board, solid cardboard, rubber, leather, low density PVC expansion sheet within 1cm

The Oscillating tool adopts the motor imported from Switzerland. It is Widely used in cutting within 5mm PVC, KT board and other medium-density material, Various types of blades 45°, 26°, 16° for choice to cut different materials.





Mini Universal Cutting Tool

UCT

Applicable models: MKC

Cutting speed	300-1200mm/s
Max thickness	≤25mm (according to different materials)
Cutting materials	PP paper, self-adhesive, magnetic material, vinyl, honeycomb, electronic film, within 5mm PVC expansion sheet, etc.

The tool itself without motor or other power output, more suitable for full-through cutting PVC materials below 5mm and rolls, light box cloth and other flexible materials, universal cutting tool is more widely used, according to the different materials to choose different angles of the blade, and determine the angle of the blade is the thickness of the material itself.

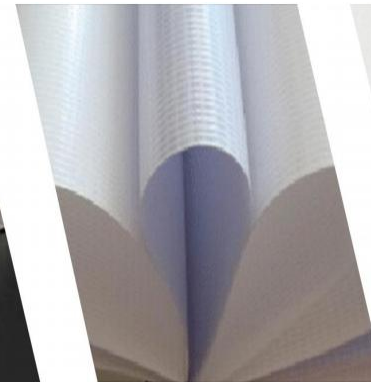

RLK

Applicable models: MKC



Graphtec Blade tool has two types of knives, 0.9mm and 1.5mm, for half-cutting adhesive-backed materials such as stickers.

Graphtec Blade



Applicable models: MCC



Cutting speed	800-2000mm/s
Max thickness	≤10mm (according to different materials)
Cutting materials	Thin fabrics,polyacrylic,balloon silk,banner cloth, coated banner, etc.
Configuration blade	Φ24 Φ28 Φ32

By high-speed rotation of the blade to cut the material, mainly for some non-woven fabrics banner cloth or other breathable materials, cutting does not take away the material, no burr, relatively fast, but can not be applied to the corner of the material is relatively small.

Driving Rotary Tool DRT



Nylon



Table runner



Glass fiber







Polyester
material



Applicable models: MCC

Cutting speed	800-2000mm/s
Max thickness	≤10mm (according to different materials)
Cutting materials	Thin fabrics,polyacrylic,balloon silk,banner cloth, coated banner, etc.
Configuration blade	Φ24 Φ28 Φ32

By high-speed rotation of the blade to cut the material, mainly for some non-woven fabrics banner cloth or other breathable materials, cutting does not take away the material, no burr, relatively fast, but can not be applied to the corner of the material is relatively small.

			
Nylon	Table runner	Glass fiber	Polyester material

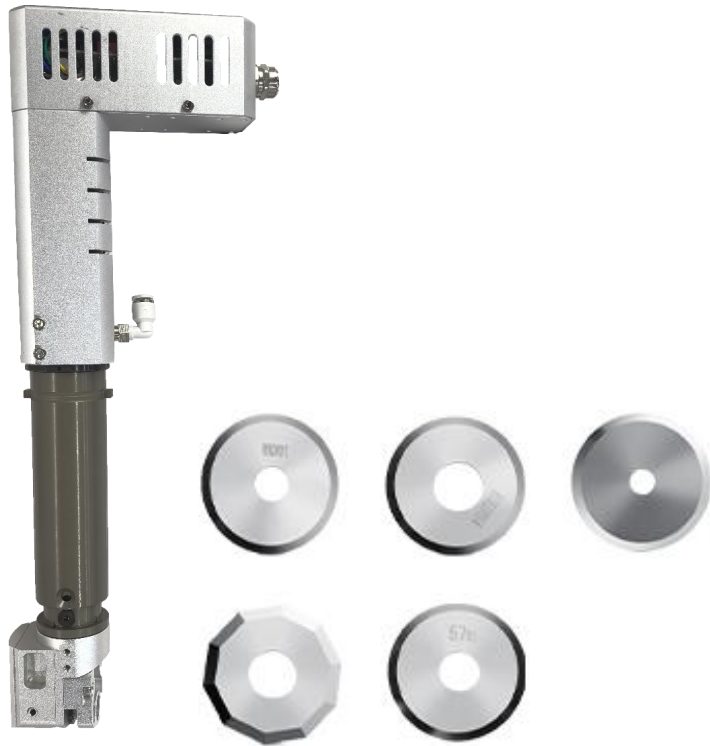

Driving Rotary Tool
DRT